

Metering With Gear Pumps

When a plant engineer is required to select and specify a chemical metering pump, the decision is often regarded as a simple choice between a reciprocating plunger pump or a diaphragm pump and gear pumps are seldom even considered. This understanding has evolved over the years until the terms metering and reciprocating pump have nearly become synonymous.

Conventional Metering Pumps ,

whether reciprocating plunger or diaphragm (disk or tubular shape), operate on the same common principle. The volume of the pumping chamber is altered by the reciprocating action, which changes the pressure exerted on the fluid being pumped. The pumping action is controlled by a pair of unidirectional check valves, Figure 1.

Displacement is determined by the plunger cross-sectional area, stroke length and cycle rate. In theory, reciprocating pumps displace a constant volume of fluid with each stroke of the plunger. In actual operation, the discharge may vary from the ideal because of erratic action of check valves or variation in the flexing action of the diaphragm during successive pulses.

In addition to check valve problems, reciprocating plunger pumps have these limitations: they deliver output in pulses, exhibit poor suction lift, are sensitive to changes in liquid viscosity, and require a complex drive for varying stroke.

The discharge from a reciprocating pump is delivered in pulses. This pulsing effect or slug feeding can be minimized by using phased duplex or triplex heads, but only with an added cost penalty. Many applications – for example, pH control, highly critical exothermic reactions, or applications in which it is necessary to monitor flow through a rotameter or an instrumented flowmeter – require uniform discharge for optimum results.

Reciprocating plunger pumps usually require a flooded suction for optimum service. They are essentially pressure intensifiers and exhibit poor suction lift characteristics. An elevated reservoir, a pressurized supply tank, or feed pump may be required with liquids that do not flow freely and liquids that have low vapor pressures.

Viscosity of the liquid entering the pump may change when the fluid is of an in-process intermediate nature, or if the temperature changes radically. When viscous liquids must be handled by reciprocating pumps, oversized suction lines and low cycle rates are required to assure that the chamber is completely filled during each stroke. When high capacities are required, the cost of the pump increases accordingly.

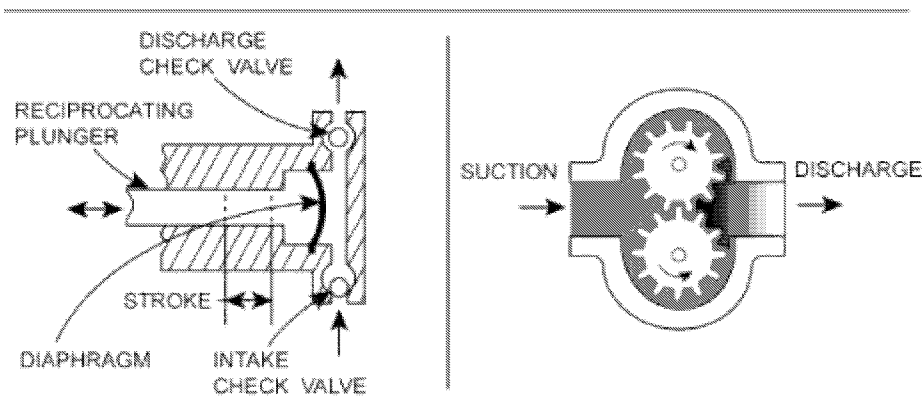
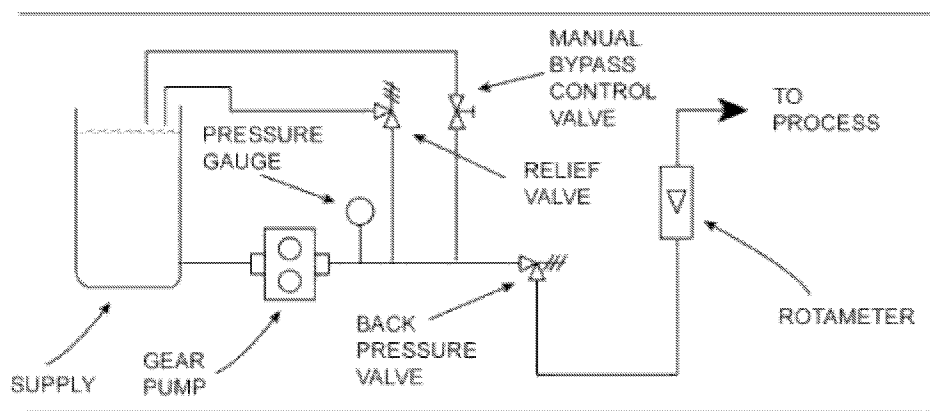

Fig 1. A pair of unidirectional check valves is required in the operation of reciprocating plunger and diaphragm pumps. Ball-check or disk-plate valves may be lightly spring-loaded to increase seating rate, but suction lift is reduced.

Fig 2. Rotary gear pumps are positive-displacement pumps operating to trap equal increments of fluid in the space between gear teeth and the pump housing for transport between intake and discharge ports.

Fig 3. Local manual bypass control system has a constant-speed pump operating to deliver a volume exceeding the maximum required by the process. The flow is divided, and the required portion is delivered to the process and the excess is returned to the supply tank. Backpressure and relief valves are used in this system for optimum performance. The backpressure valve maintains constant pressure in the discharge line. Flow to the process is precisely controlled by adjustment of the bypass control valve. The relief valve protects the pump and other system components against over-pressure. Output from the relief valve should always be piped to the supply tank, or to a safe drain, and never returned to the pump intake.



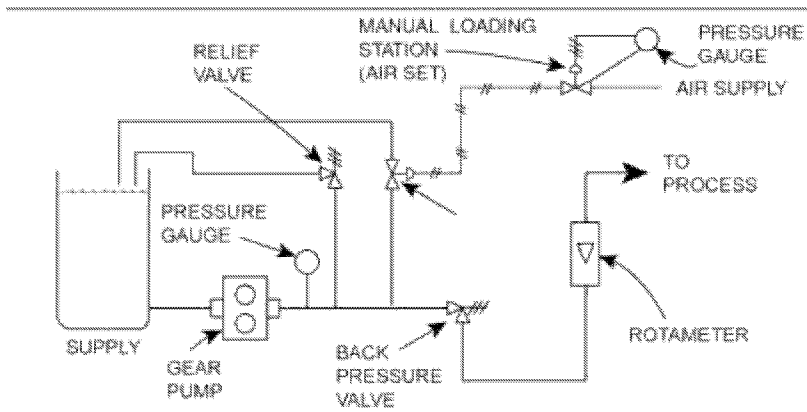

Fig 4. Remote manual bypass control can be provided by replacing the manual bypass valve shown in Figure 3 with an air or electrically operated control valve. The bypass control valve is then made a slave to a remote pneumatic or electrical manual loading station.

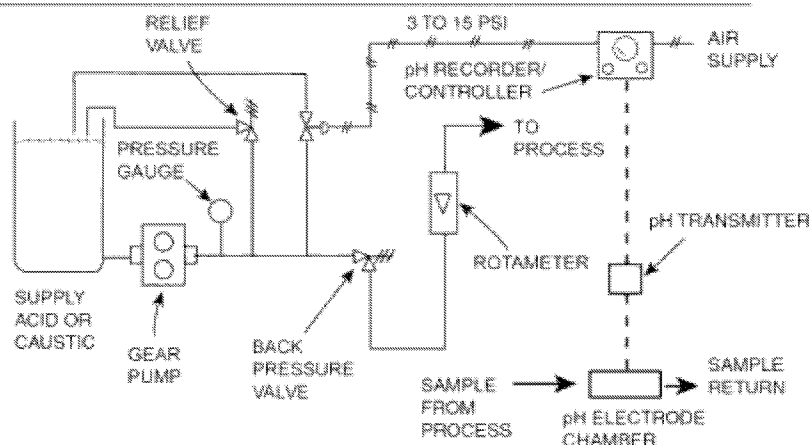
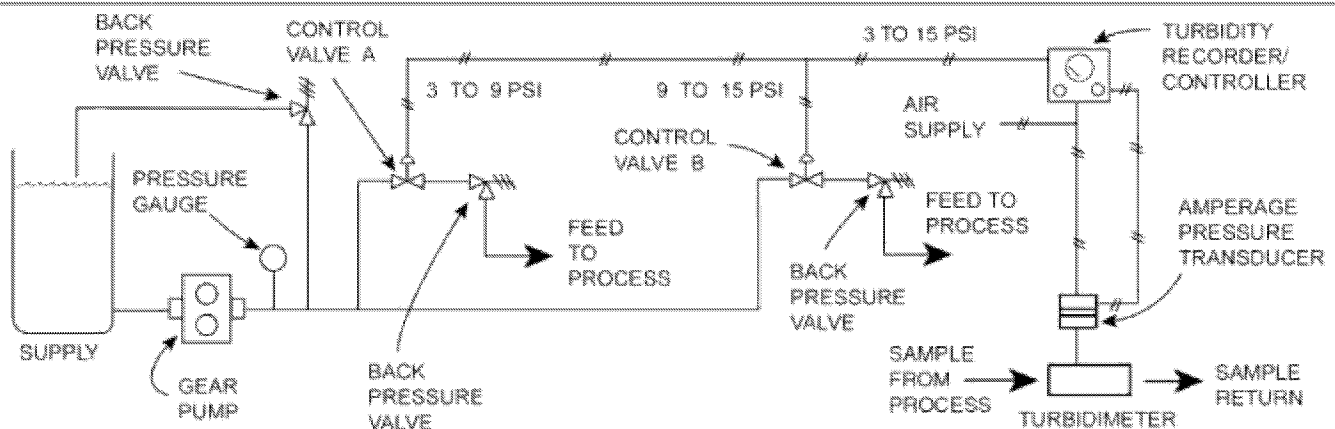

Fig 5. Remote automatic bypass control is provided with the bypass system shown in Figure 4 by feeding the signal from a suitable controller, in this case pH, to the control valve in the bypass line. This basic automatic control system may be used in a variety of applications in which an output signal is available from a control device such as a temperature, pressure or turbidity monitoring controller. The system is simple to troubleshoot and allows a range change (within limits) by changing the valve trim.

Fig 6. Dual-rate output bypass control is illustrative of a two-level system for turbidity control or other similar service. Under certain conditions a system must be designed to cope with an occasional upset when a greatly increased volume of liquid is temporarily required. In the system illustrated, an oversized pump is used with two control valves.



The ability to vary the stroke length during operation increases the complexity of the drive design in reciprocating metering pumps. Several methods are available: direct stroke adjustment, eccentric cam adjustment, and lost-motion devices to limit movement of the plunger during a portion of the return stroke.

An Alternative Method – In many applications, specifically when high pressures are required, the reciprocating pump is preferable, if not the only choice. The rotary gear pump is an alternative that should not be overlooked for low to moderate-pressure (100 psig or less) applications.

The rotary gear pump merits consideration because it overcomes many of the problems encountered with reciprocating metering pumps and is generally much less expensive. The cost factor is particularly significant when pumped liquids require corrosion-resistant materials.

The rotary gear pump operates by picking up fluid at the suction port in the cavities formed between the gear teeth and housing, and carrying the fluid around the outer diameter of the gears to the discharge port, Figure 2.

Under normal operating conditions the flow rate is controlled by Valve A operating on a control signal of 3 to 9 psi. In the event of an upset causing a demand for a quantity of treatment chemical exceeding the maximum that will pass Valve A, Valve B is operated by the 9 to 15 psi signal to satisfy the increased demand of treatment chemical required by the process system.

“The degree of accuracy is a function of instrumentation accuracy and the degree of sophistication used in the design of the control system.”

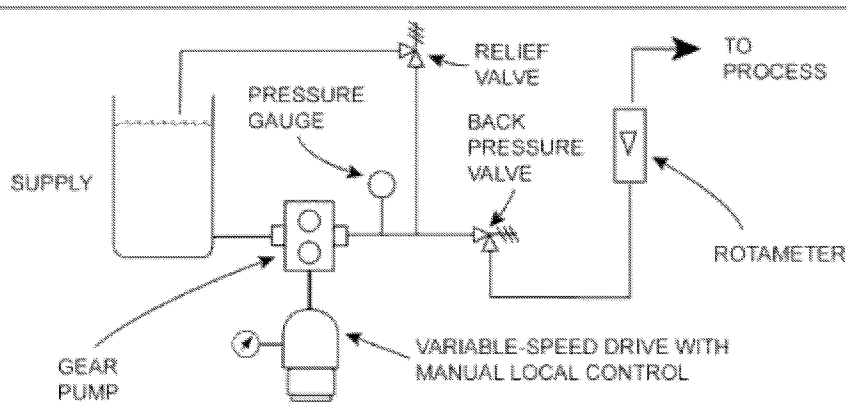

Fig 7. Local manual variable-speed control can be based on a number of variable-speed drives: mechanical-speed drive, hydraulic transmission, air motor, or silicon-controlled rectifier (SCR) drive. A variable-speed drive with manual adjustment is illustrated.

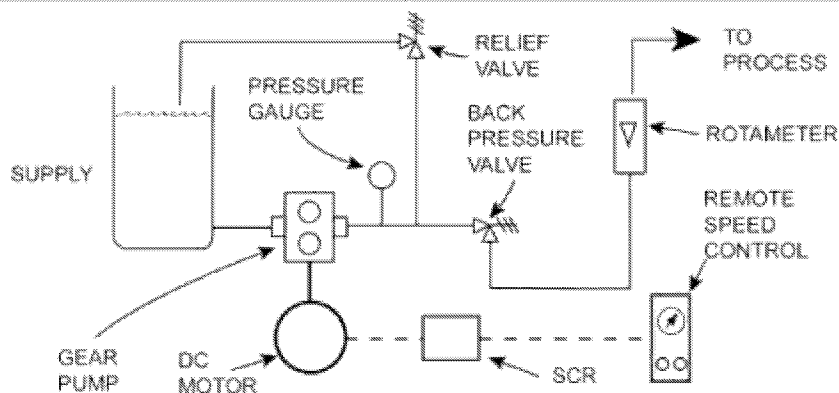
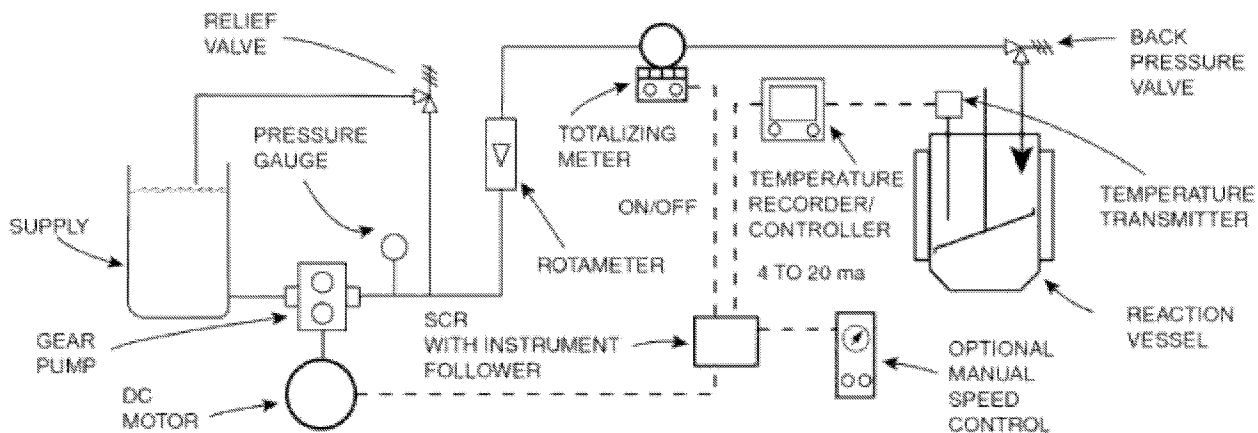

Fig 8. Remote manual variable-speed control changes feed rate by using a mechanical or hydraulic variable-speed drive equipped with a pneumatic or electrical operator, or an SCR drive with a remote control station.

Fig 9. Remote automatic variable-speed control uses the basic system illustrated in Fig 8. The variable-speed device is controlled by an output signal (air or electrical) received from a control device, typically a temperature controller monitoring reaction temperature and using the change in this signal as the basis for changing the feed rate. A totalizing meter added to the system limits the total quantity of reactant used. The meter stops the pump when a predetermined amount of reactant has been added to the system.



By design, it displaces a relatively constant volume per revolution and delivers essentially pulse-free linear flow. The quantity of fluid (flow rate) delivered to the process may be varied in three basic ways, with varying degrees of control sophistication:

- Bypass metering – local manual control, Figure 3; remote manual control, Figure 4; remote automatic control, Figure 5; or dual-rate output control, Figure 6.
- Variable speed metering – local manual control, Figure 7; remote manual control, Figure 8; or remote automatic control, Figure 9.
- Ratio metering – local manual control, Figure 10; or remote automatic control, with a combination of variable-speed and bypass metering, Figure 11.

The basic systems shown in Figures 3 to 11 are representative of applications in which positive-displacement rotary gear pumps can be used for low-pressure chemical metering applications. The degree of accuracy is a function of instrumentation accuracy and the degree of sophistication used in design of the control system.

The advantages of using a rotary gear pump in metering applications include low initial cost, minimum maintenance, and simplicity of the system.

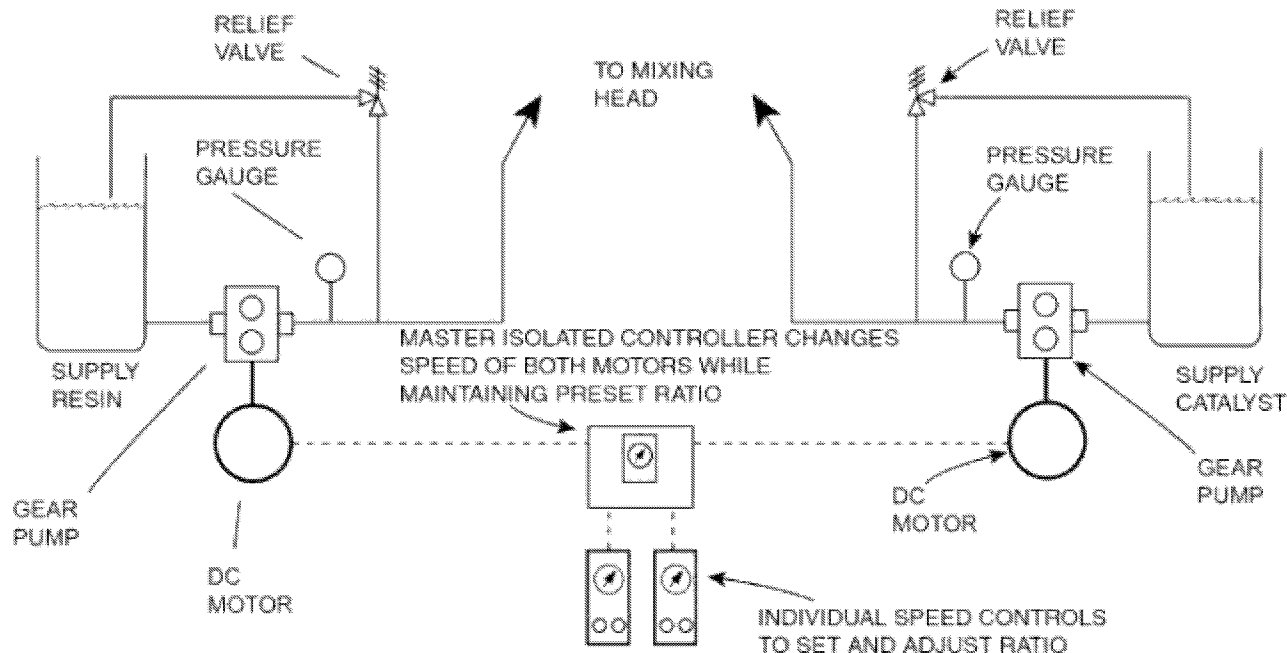
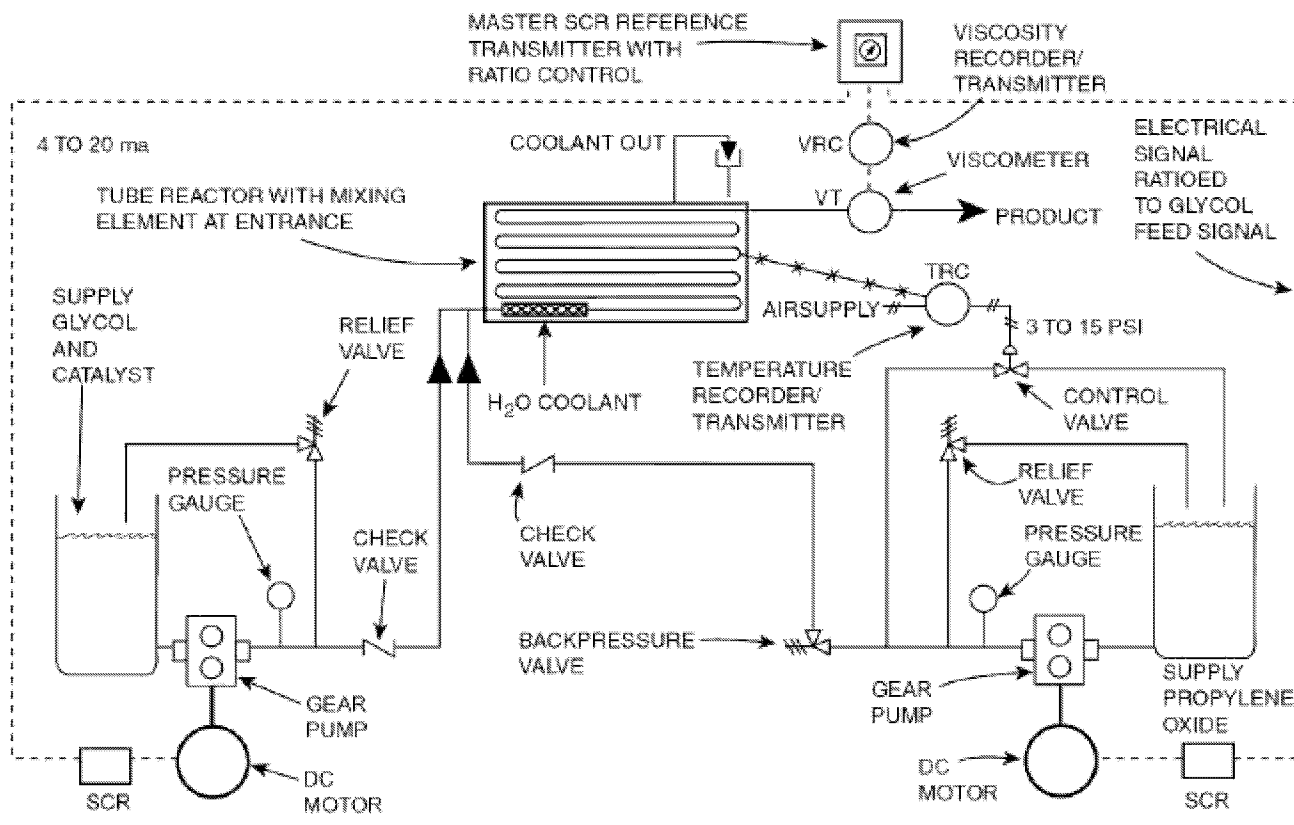

Fig 10. Local manual ratio metering control can be used to merge two or more liquid streams such as a resin and catalyst, at a constant ratio using an SCR package with speed control for each pump. After the ratio between streams is established, the total quantity can be changed without disturbing the original ratio.

Fig 11. Remote automatic system uses a combination of variable speed and bypass control. A viscometer determines residence time and adjusts rate of glycol feed. Propylene oxide feed is automatically controlled at a ratio adjustable to the rate of glycol feed. Temperature controller reduces propylene oxide feed rate to control reaction temperatures in the event the ratio control system calls for a quantity of propylene oxide that would result in a larger exothermic reaction than the system is capable of handling.





PULSAFEEDER
A Unit of IDEX Corporation

IDEX
IDEX CORPORATION



Engineered Pump Operations
2883 Brighton-Henrietta Town Line Road
Rochester, New York 14623
Telephone: (716) 292-8000
Fax: (716) 424-5619
<http://www.pulsa.com> – E-mail: pulsa@pulsa.com